

**TESSERA**<sup>4</sup>  
OFF ROAD ACCESSORIES  
**4X**  
*Think Quality!*



Tessera4x4

**TESSERA ROLL+**

**"UNIQUE INNOVATION CRAFTED WITH QUALITY!"**

TEX

4x4

**Time to make a statement!**  
**Peerless Refinement & Power**  
for your pickup truck.





Details matter...



Side rail parts with built in T-SLOTS. Easy & secure installation, with NO DRILL of extra accessories: Roll Bars, Side handrails and Cross Racks.

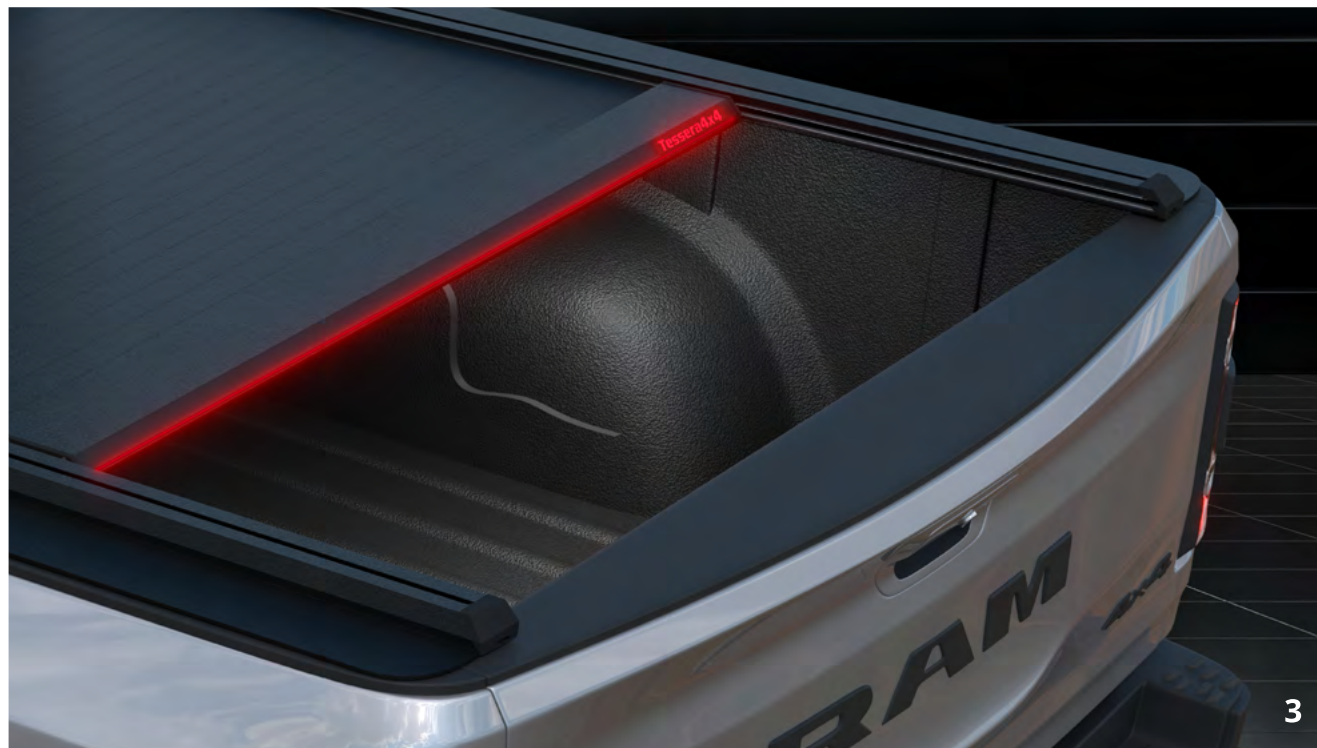







**Discover the Unrivaled  
Elegance of Tessera4x4:  
Elevate Your Ride with Exclusive  
Black Matt Accessories  
Crafted from Powder  
Coated Stainless Steel!**







**Introducing Our  
Premium Roll Top Cover:  
Engineered for Unrivaled  
Durability and Practicality,  
Enhanced with Exclusive  
Stainless Steel Accessories.**









**Mobile App:**  
Intelligent  
Control  
at Your  
Fingertips.



**Key Fob  
Remote:**  
Crafted for  
Effortless  
Convenience.

## Tessera Roll+ 4 Operational Modes



**Unique rear slat  
that also  
functions as an  
open-close  
switch.**



**Voice Command  
Mode: Elevated  
Hands-Free  
Control.**



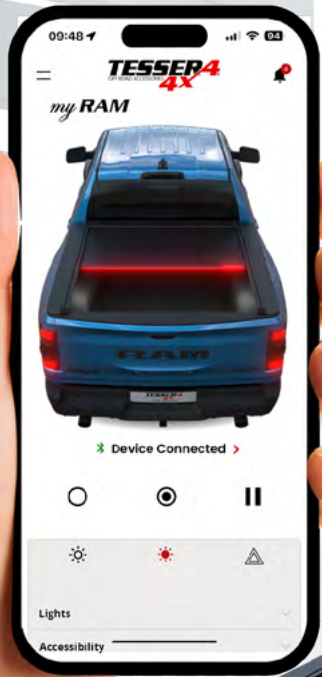

Real Time animation & notifications



# TESSERA Roll+ Mobile App: Revolutionizing Your Daily Experience with Seamless Configurations and Interactions!

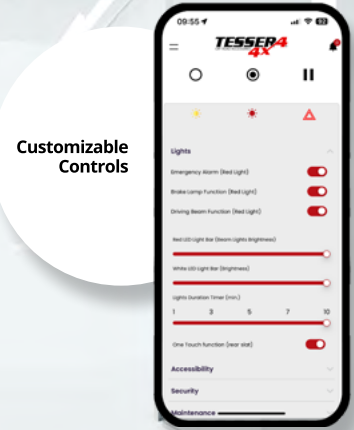

Customizable Controls

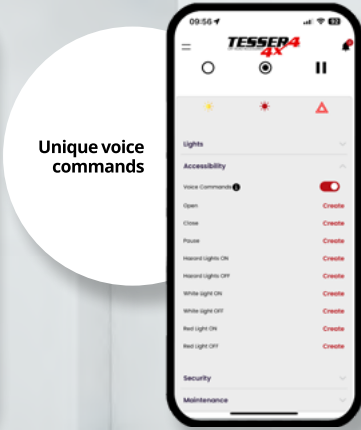

Unique voice commands



Unique security settings

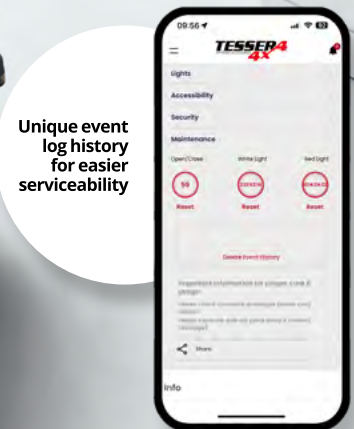

Unique event log history for easier serviceability



Elevate Your Roll Top Experience with Exclusive FW Board Updates!

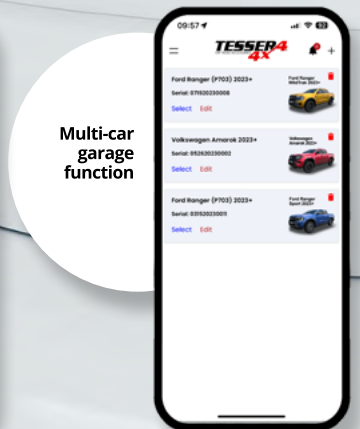

Multi-car garage function

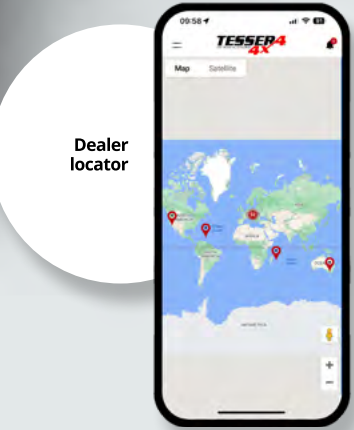

Dealer locator

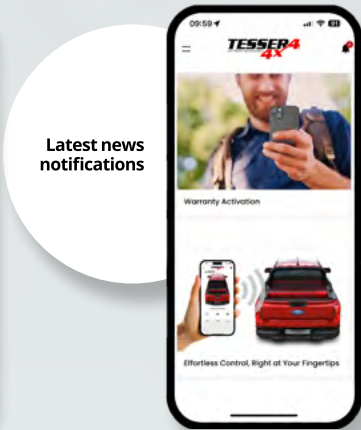

Latest news notifications

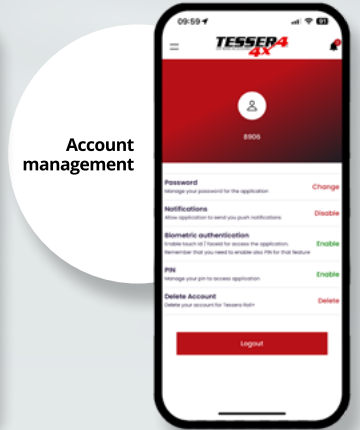

Account management



# 3 in 1 Mod

## BASIC VERSION

- **Unique, smooth, easy opening system without any assistance.**
- **Unique design – upgrade anytime.** Easy upgrade from **Basic to Spring or Electric version** by **JUST** adding the kit of your preference. Easy downgrade whenever needed.
- **Basic version, is the base of all versions.** Distributors and wholesalers can stock **1 SKU** (basic version) and add the **E-Kit** or **S-Kit** whenever needed, thus decreasing the number of SKUs by almost **2 times**.



## BASIC VERSION + S-KIT ⚙️



- **Upgrade from Basic to Spring version** by simply adding the **S-Kit**.
- **Spring-assisted opening** for an even easier opening.



## BASIC VERSION + E-KIT ⚡

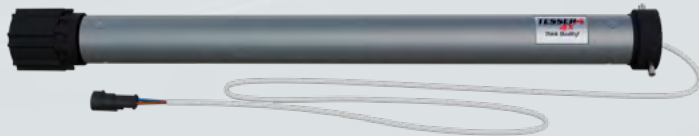

- **Upgrade from the Basic version** to the AI-Powered version using the **E-Kit**.
- Put the **power of AI** at your fingertips with a host of benefits such as:
  - **Open and close** your roll top cover using the specially designed **key fob**, **one-touch** rear slat, the unique **Tessera Roll+ App** or simply using **voice commands**.
  - **Forgot** your roll top cover open? Tessera Roll+ App will **remind you to close it**.
  - **Maintenance** notifications.
- **Use the power of AI** for your convenience, ease of use, and infinite possibilities of customization.
- **Proximity** safety sensors.
- **No need** for motor calibration.

In addition to a host of other features and benefits that would amaze and surprise anyone that they could be incorporated in a roll-top cover.





# ular Design

**BASIC VERSION**

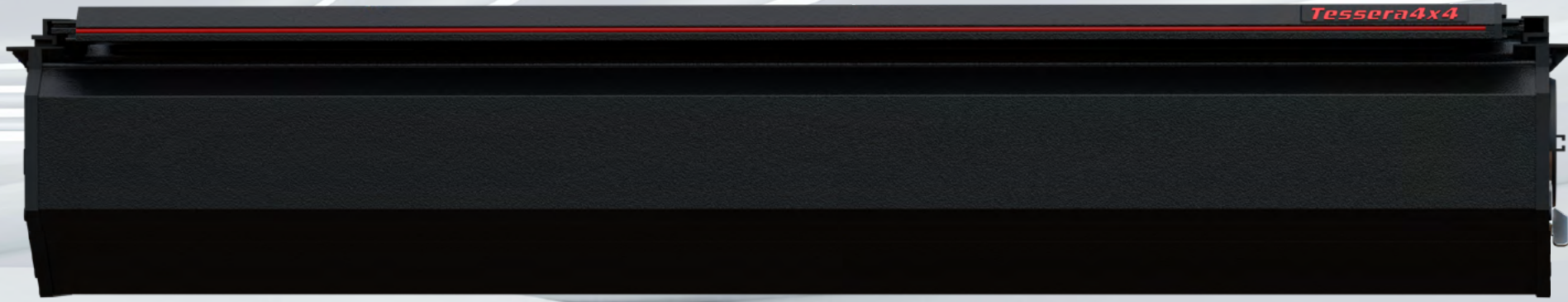

**BASIC VERSION + S-KIT**

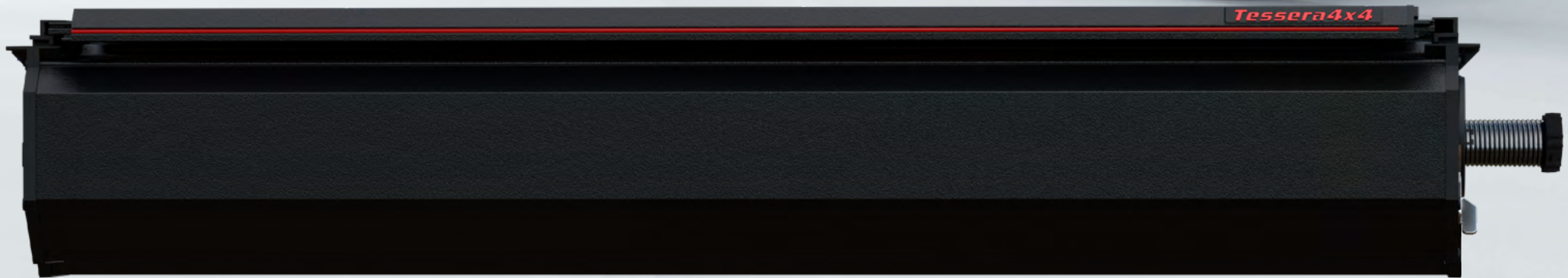

**BASIC VERSION + E-KIT**

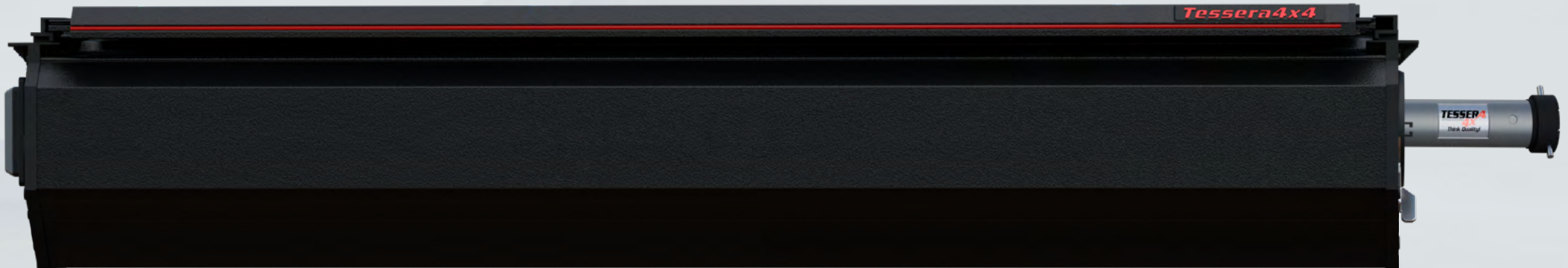



**Sealed & Water  
Proof resistant  
electric motor**

**Located & protected  
inside the aluminium  
(heavy duty)  
central shaft.**

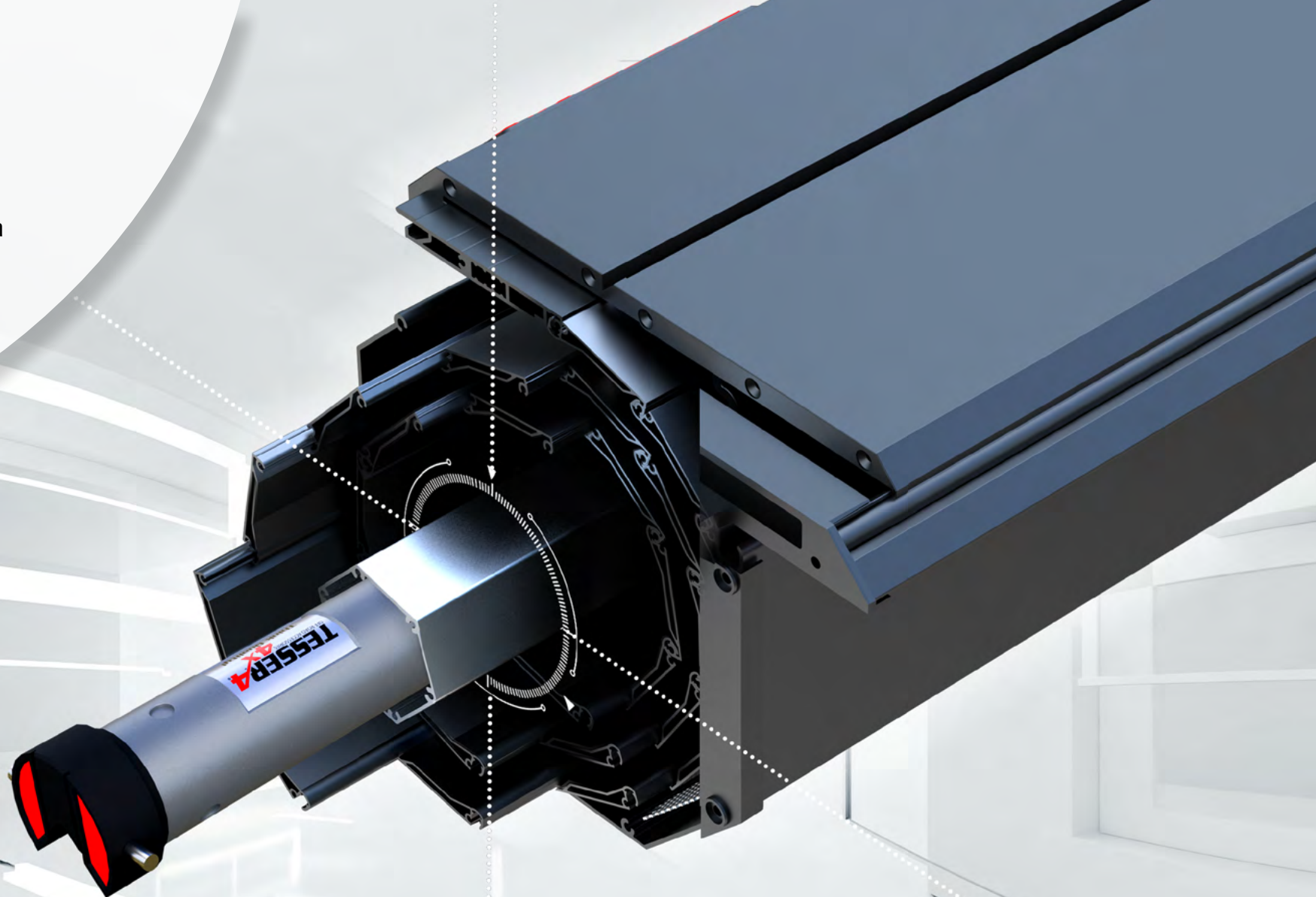



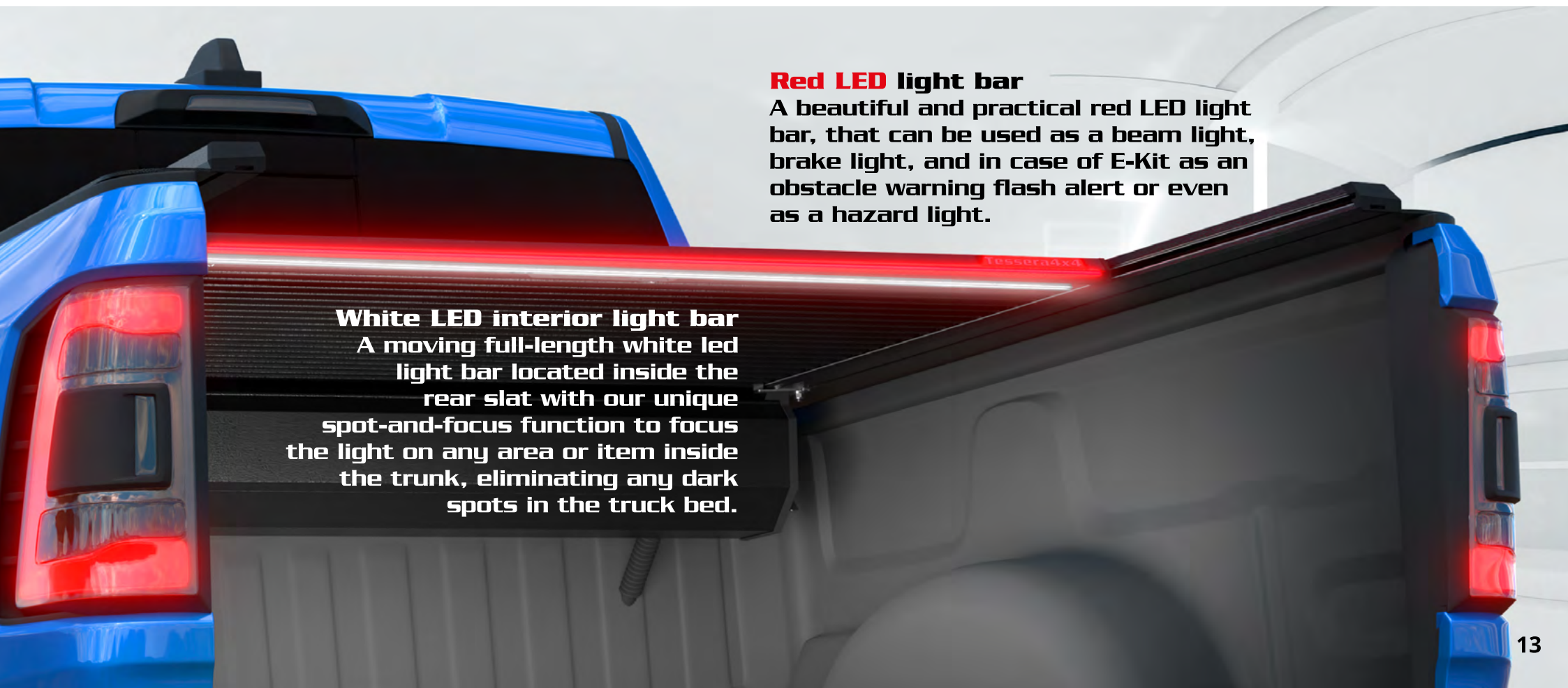
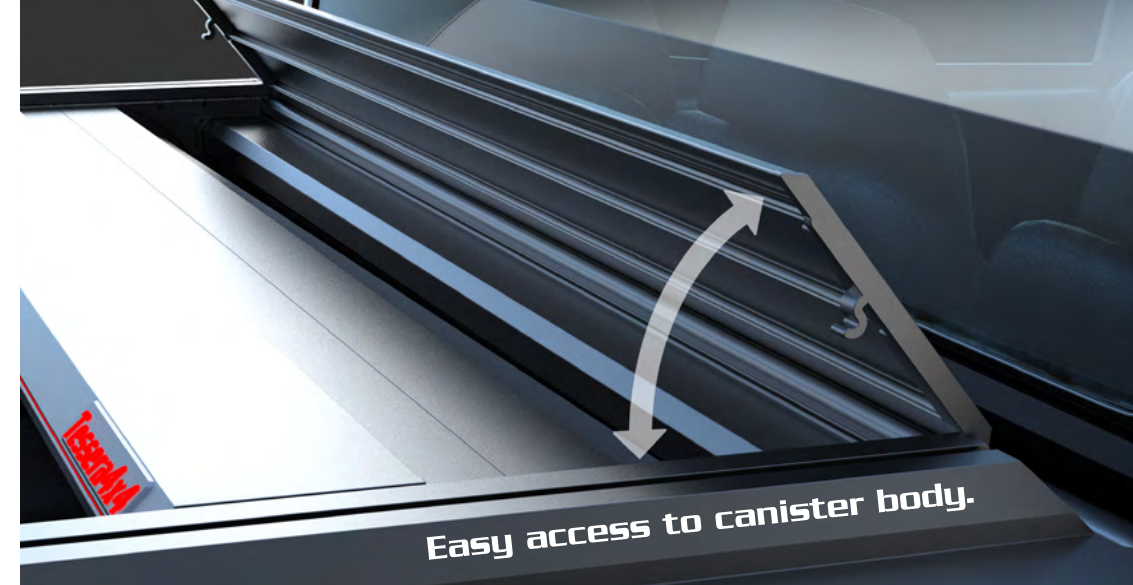

### **Red LED light bar**

A beautiful and practical red LED light bar, that can be used as a beam light, brake light, and in case of E-Kit as an obstacle warning flash alert or even as a hazard light.

### **White LED interior light bar**

A moving full-length white led light bar located inside the rear slat with our unique spot-and-focus function to focus the light on any area or item inside the trunk, eliminating any dark spots in the truck bed.



*Our specially designed rear slat now goes inside the canister area.*

*An innovative design that offers the advantage of maximizing load net capacity both in length & height.*

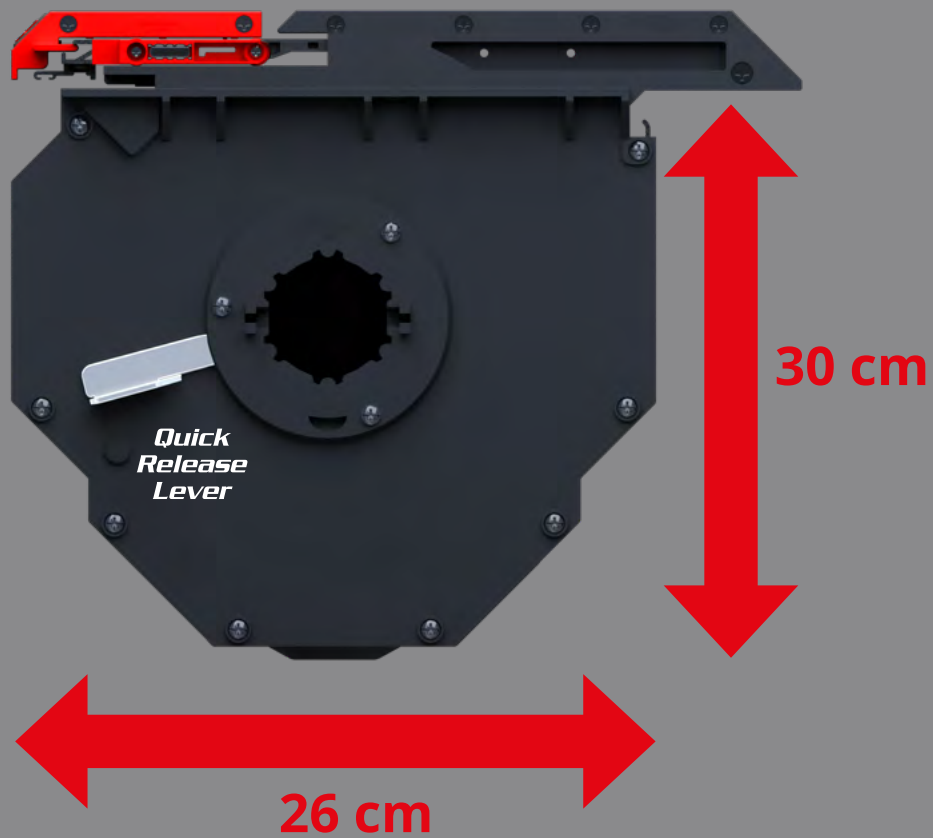

**KNIFE PROOF**  
Specially designed "Knife proof" slats provide 100% security for the load.



Interior Locking system for preventing unauthorised access.



**Aluminium locking teeth**  
Specially designed interior automatic locking system, the only one with aluminium locking teeth for maximum security (no plastic).

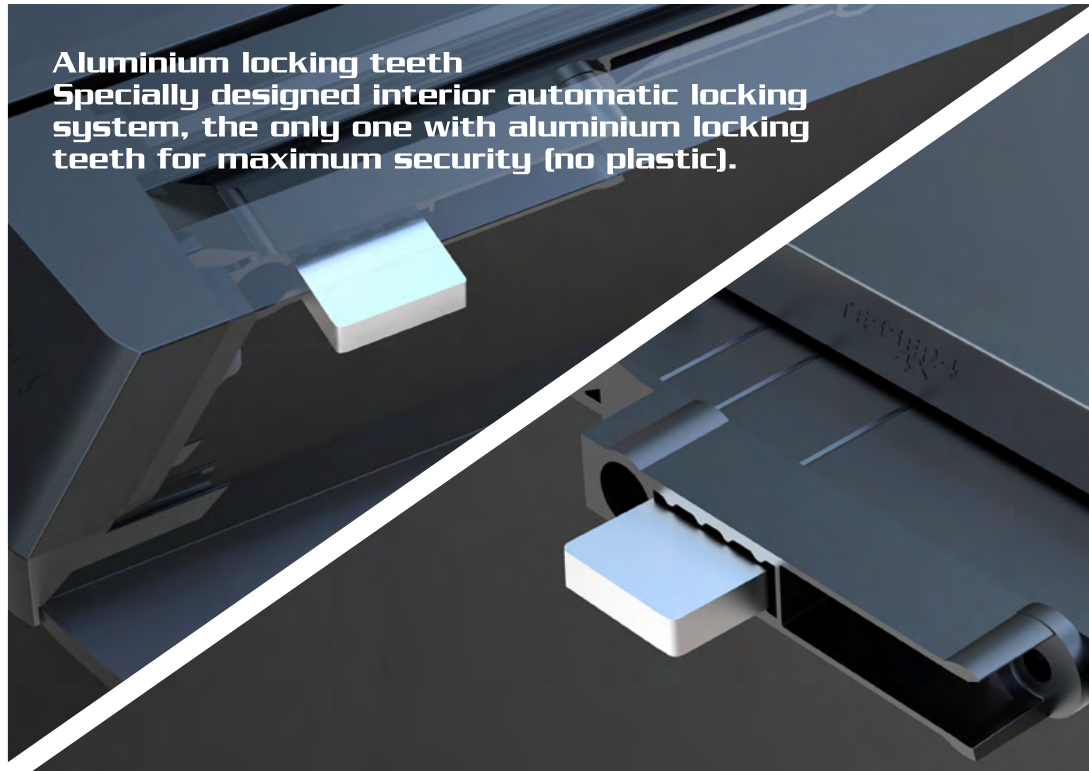





**WATER PROTECTION:**  
2 main oversize  
drainage systems for  
fast water drainage.

**2 overflowing systems**  
in the canister body.

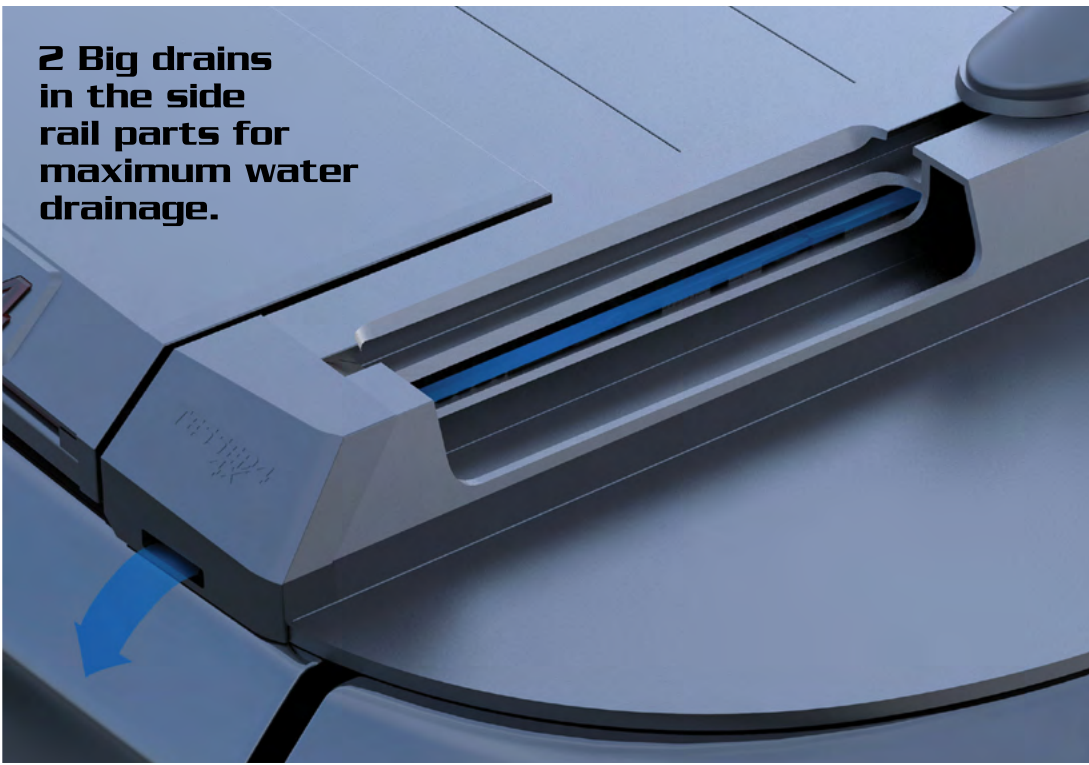

**2 Big drains**  
in the side  
rail parts for  
maximum water  
drainage.



**ANTI-LEAF SYSTEM:**  
The only roll top cover  
on the global market with  
a specially designed anti-  
obstruction system (anti-leaf  
system), to protect the water  
drains of the canister from  
leaves and small obstructing  
objects.

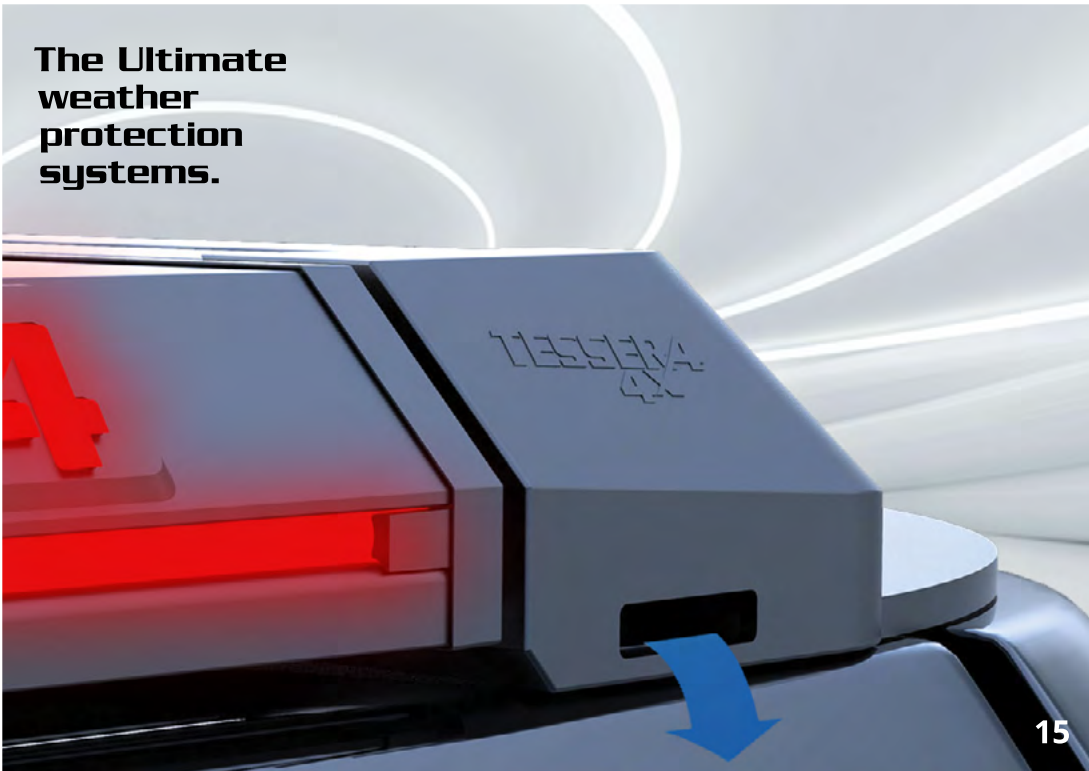

**The Ultimate**  
weather  
protection  
systems.



<b>Why Tessera Roll+? Top Benefits</b>	<b>Wholesalers</b>	<b>Wholesalers / End customers</b>	<b>Competition</b>
<ul style="list-style-type: none"> <li>● <b>Modular Design 3 in 1</b> By ordering just 1 product code per model, Tessera Roll+ could be transformed to 3 different product codes. This means:</li> </ul>	✓	✓	✗
✓ No need of three times more space to warehouse	✓	—	✗
✓ Three times less shipping costs	✓	—	✗
✓ Lower risk for remaining stock (1 product vs 3)	✓	—	✗
✓ Easier order forecast	✓	—	✗
✓ Easy transformation with s-kit or e-kit with no use of tools (Quick Release Lever) or special knowledge	✓	✓	✗
✓ Gives the benefit to the end customer to upgrade his Tessera Roll+ at any time	✓	✓	✗
<ul style="list-style-type: none"> <li>● <b>Smart AI Control Board</b> The only roll top cover in the global market with Artificial Intelligence board. This means:</li> </ul>	✓	✓	✗
✓ <b>Auto calibration of motor</b> (no need of a special procedure in case of first fitting, replacement of motor and in case in low temperatures)	✓	✓	✗
✓ <b>Maintenance alerts</b> The most common claims for all roll top covers around the world are for maintenance. For the end users is not easy to remember to follow the proper care and usage instructions and as a result they identify or realise the problems too late. As a consequence they will have to be charged for additional costs of the damaged spare parts or they won't have the proper functionality to their roll tops. Now Tessera Roll+ users have the advantage to receive pop up maintenance alerts directly to their mobile as they stay connected with their Tessera Roll+ all the time. So they will be notified for the most important and common issues like:	✓	✓	✗
a) <b>Canister's cleaning</b> In case of blocked water inside the canister's area (it prevents problems to the whole structure or in cases with spring/motor)	✓	✓	✗
b) <b>Side rails parts cleaning &amp; lubricating</b> It calculates the time that the roll needs to open and close and after 10 confirmations it notifies you that the standard period is exceeded	✓	✓	✗
c) <b>Motor failure</b>	✓	✓	✗
✓ <b>Share event history</b> Tessera Roll+ users can view and share the event history and functionality of their roll. This means the best after sales care service that the final users could imagine	✓	✓	✗
✓ <b>4 MODES of operation</b>	✓	✓	✗
a) <b>Specially designed remote controls</b>	✓	✓	✗
b) <b>Mobile app +</b>	✓	✓	✗
c) <b>Voice Commands</b>	✓	✓	✗
d) <b>The unique "ONE Touch" function.</b> This means that the rear slat functions as huge aluminium button (there are not physical buttons to the side rails like in competition where are not working in low temperatures and are easy to be damaged as they are exposed to weather conditions and in case of stealing)	✓	✓	✗
<ul style="list-style-type: none"> <li>● <b>Electricity to rolling part</b> Tessera4x4 is the only company in the world that managed to transform electricity to the rolling part and as a result:</li> </ul>	✓	✓	✗



<b>Why Tessera Roll+? Top Benefits</b>	<b>Wholesalers</b>	<b>Wholesalers / End customers</b>	<b>Competition</b>
a) <b>To put a beautiful and practical red LED light bar</b> , that can be used as a beam light, brake light, and in case of E-Kit as an obstacle warning flash alert or even as a hazard light	✓	✓	✗
b) <b>To have a moving full-length white led light bar</b> located inside the rear slat with our unique spot-and-focus function to focus the light on any area or item inside the trunk, eliminating any dark spots in the truck bed	✓	✓	✗
c) <b>To put physicals sensors</b> into the end slat as a result to function as physical main control button and as an obstacle sensor	✓	✓	✗
● <b>Obstacle physical sensors</b> Since physical sensors are embedded to the end slat, Tessera Roll+ senses directly (in real time) the obstacle with no use of motor current. All the competition uses the motor current to sense obstacles which means that they are not 100% secure especially in children's cases. Also, by using motor current then the motor will be damaged quicker	✓	✓	✗
● <b>Heavy-duty shaft</b> Located inside canister's area. Within shaft could be located the spring (s-Kit) or electric motor (e-Kit), to be sealed and protected. As a result, we take no extra space of the trunk area to put motor (in comparison with the competition located in a separate side box outside the canister or located in 2nd shaft with bigger canister) or unprotected to the trunk bed	✓	✓	✗
● <b>Innovative design &amp; Compact size</b> Rear slat goes inside to the canister's area in combination of the smallest canister's dimensions (20cm x 23cm) (Space cab / Single cab / American models 26cm x 30cm (HxW)), offers the advantage of maximizing load net capacity both in length and height. In comparison with the competition that the end slat exceeds from the canister area	✓	✓	✗
● <b>Mobile App Configurations</b> Experience a whole new environment of configurations	✓	✓	✗
a) <b>Lights adjustments like:</b> on/off, brightness of red/white lights, timer of lights, etc.	✓	✓	✗
b) <b>Easy pairing of new remote controls</b> in case of lost remote controls	✓	✓	✗
c) <b>Many security settings</b> (like left opened Reminder, Double-Click function, etc.,)	✓	✓	✗
d) <b>Monitoring your Tessera Roll+ operation circles</b> , lights and share events	✓	✓	✗
e) <b>Online installation guides, videos</b> , brochures and closest dealers support	✓	✓	✗
● <b>The one and only Anti-Leaf System (ALS)</b> Tessera Roll+ is the only roll top cover in the global market with a specially made obstruction system (anti-leaf system), to protect the water drains of canister from leaves and small trash	✓	✓	✗
● <b>Side rail parts (5mm thickness)</b> Specially made (100% handmade) side rails with 5mm thickness, which follows 100% the shape and the design of the trunk's rail parts (in length and width). This offers the following benefits:	✓	✓	✗
a) <b>Better insulation</b> from any weather conditions	✓	✓	✗
b) <b>Reinforce</b> the vehicle's rail parts	✓	✓	✗
c) <b>Free surface to drill</b> in order to install all types of roll bars, side handrails and loading bars (in cases of heavy usage)	✓	✓	✗
● <b>Aluminium Locking Teeth (ALT)</b> The only roll top cover with "AUTOMATIC ALUMINIUM" locking teeth for maximum security (no plastic) of the load	✓	✓	✗

Summary Features List (per version of Tessera Roll+ series)	Basic Version	Basic version + S-Kit	Basic version + E-Kit
<b>Motion</b>			
✓ Manual (no spring/no motor)	✓		
✓ Spring		✓	
✓ Motor			✓
<b>Operation</b>			
✓ Strap (Manual)	✓	✓	
✓ 4 MODES of operation (Remote control/Mobile App/Voice Commands/One Touch)			✓
<b>Lights</b>			
● Red Led Light Bar:	✓	✓	✓
✓ Beam light	✓	✓	✓
✓ Beam light ON/OFF (Mobile App)			✓
✓ Brake light	✓	✓	✓
✓ Brake light ON/OFF (Mobile App)			✓
✓ Emergency hazard lights system			✓
✓ Emergency hazard lights system ON/OFF (Mobile App)			✓
✓ Obstacle warning flash alert			✓
✓ Adjust brightness of beam lights			✓
● White Led Light Bar:	✓	✓	✓
✓ Switch ON/OFF	✓	✓	
✓ Remote control ON/OFF			✓
✓ Mobile App ON/OFF			✓
✓ Timer configuration (min.)			✓
✓ Adjust brightness			✓
<b>Security   Protection</b>			
✓ Obstacle feature (with physical sensors)			✓
✓ Auto stop & locking feature			✓
✓ Knife proof slats	✓	✓	✓
✓ Internal Locking System (ILS)	✓	✓	✓
✓ Aluminium Locking Teeth (ALT)	✓	✓	✓
✓ Central shaft (Direct Drive System)	✓	✓	✓
✓ Electric motor & spring (DDS) located to shaft		✓	✓
✓ Side rail drainages	✓	✓	✓
✓ 2 main drains into the canister area Ø20	✓	✓	✓



Summary Features List (per version of Tessera Roll+ series)	Basic Version	Basic version + S-Kit	Basic version + E-Kit
✓ Anti-Leaf System (ALS)	✓	✓	✓
✓ Slats with embedded silicon seal	✓	✓	✓
✓ Biometric authentication to App, Pin code to App, Bluetooth pin to App			✓
✓ Double-Click function			✓
✓ Tessera Roll+ left opened Reminder			✓
<b>Practicality</b>			
✓ 3 in 1 Modular Design (Quick Lever)	✓	✓	✓
✓ No need motor calibration			✓
✓ Soft open/close feature			✓
✓ Auto stop & locking feature			✓
✓ Accessibility with Siri/Google Assistant etc.,			✓
✓ ONE Touch function ON/OFF			✓
✓ Smallest canister's dimensions (Double cabs: 20cm x 23cm & Space/Single/American models: 26cm x 30cm)	✓	✓	✓
✓ Specially made side rail parts (5mm thickness)	✓	✓	✓
✓ Quick installation	✓	✓	✓
✓ Installation with all types of Bedliners (over/under rail)	✓	✓	✓
✓ T-slots rack for NO Drill accessories	✓	✓	✓
✓ Installation kit for roll bars & side handrails with <b>NO Drill</b> (light use max 70kg)	✓	✓	✓
✓ Vertical clearance	✓	✓	✓
✓ Aerodynamics to boost fuel economy	✓	✓	✓
<b>Maintenance</b>			
✓ Maintenance pop up alerts (Blocked water in canister, clean & lubricate side rails & motor failure)			✓
✓ Operation circles (roll open-close, lights time)			✓
✓ Share event history of general operation			✓
✓ New remote controls pairing			✓
✓ Clear paired remote controls			✓
✓ Bluetooth ON/OFF			✓
✓ Easy access to canister's body any time	✓	✓	✓
✓ Maintenance Free (DTS) in transmission system	✓	✓	✓
✓ Next generation powder coat finish	✓	✓	✓
<b>Patents   Certificates</b>			
✓ 8 Patents	✓	✓	✓
✓ 3 Certificates	✓	✓	✓

# Tessera Roll+ series:

Introducing Tessera Roll+: Your Pickup's Ultimate Upgrade.

For the first time ever, Tessera Roll+ sets a new standard as the only roll top cover worldwide to incorporate Artificial Intelligence, revolutionizing convenience, maintenance, security, and customization. With 8 patents and meticulous Greek craftsmanship, each Tessera Roll+ boasts unmatched quality and finish.

- **Upgrade from manual to spring-assisted or AI electrical operation**, or even downgrade at your convenience, making it budget-friendly for retail customers and efficient for wholesalers.
- **Harness the power of AI for seamless operation**, proactive maintenance notifications, and four modes of operation, including **key FOB remote, one-touch rear slat, Tessera Roll+ App, or voice commands**.
- **Protect your loved ones with proximity sensors** and enhance safety and style with a versatile red LED light bar.
- **Crafted from nearly 50-60kg of aluminum, Tessera Roll+** withstands extreme conditions with oversized drains, anti-leaf system, water-resistant design, & knife-proof slats.
- **Elevate your pickup truck with Tessera Roll+** – the toughest, most feature-rich roll top cover on the market, delivering functionality and style in one sleek package

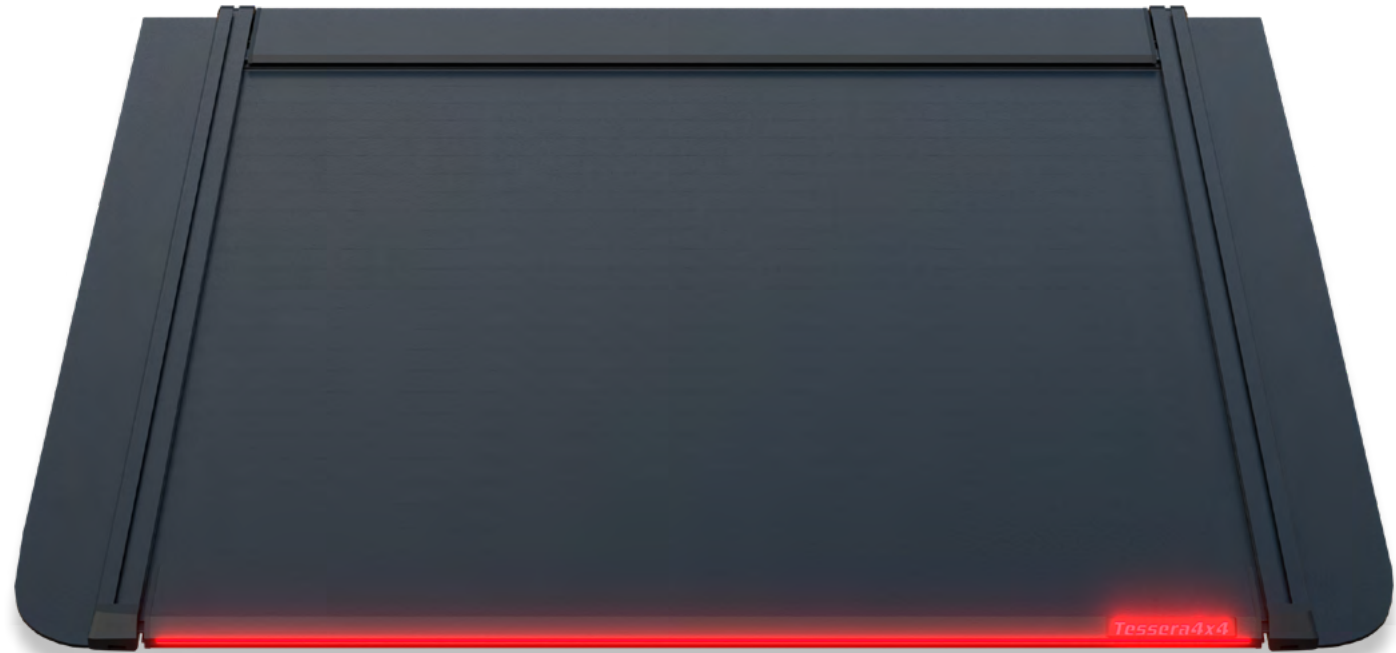

TESS 1424 ROLL	Dodge Ram 2019+ (1500 - 1500 TRX - 1500 CLASSIC)	Short-Bed-5.7-feet
TESS 14241 ROLL	Dodge Ram 2019+ (1500 - 1500 TRX - 1500 CLASSIC)	Long-Bed-6.4-feet
TESS 1438 ROLL	Dodge Ram 2500 / 3500 2019+	Short-Bed-6.4-feet
TESS 14381 ROLL	Dodge Ram 2500 / 3500 2019+	Long-bed-8-feet
S-KIT	(SPRING KIT)	
E-KIT	(ELECTRIC KIT)	



## Roll Bars:

Elevate Your Truck with Our Premium Stainless Steel or Stainless steel painted in Black Matt\* Sport Design Roll Bars.

- **Elevate Your Style:** Our patented design brings a sleek and sporty look to your truck.
- **Built to Last:** Crafted from high-quality 65mm Stainless Steel Pipes (304L) for durability and longevity.
- **Perfect Fit:** Detachable design allows for seamless adaptation to the dimensions of any truck's bed.
- **Ultimate Support:** With a one-piece construction, our roll bar provides strong support, ensuring resistance during loading.
- **Customizable Options:** Includes a special plate for easy installation of fog lamps, enhancing both style and functionality.
- **Safety First:** Offers protection for the cabin in the event of a fall or accident, keeping you and your truck safe on the road.

\* (BLACK MATT: painted in 180°C for 30 minutes, an advanced process certified with the international standards 9001:2000 (Quality Management Systems) & 14001:2004 (Environmental Management Systems) and «SEASIDE CLASS» quality seal of the company QUALICOAT)).

---

**Upgrade your truck with the ultimate blend of style, strength, and safety. Elevate your driving experience with our Stainless Steel Sport Design Roll Bar today!**



CODE: RB 4073 INOX BLACK



CODE: RB 4073 INOX



CODE: RB 4063 INOX BLACK



CODE: RB 4063 INOX



CODE: RB 4062 INOX BLACK



CODE: RB 4062 INOX



CODE: RB 4072 INOX BLACK



CODE: RB 4072 INOX

## Side Handrails:

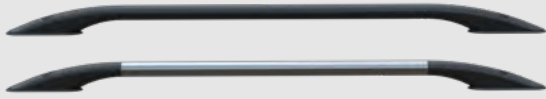

### CODE:

KOY 80 SPORT INOX BLACK / KOY 80 SPORT INOX  
KOY 105 SPORT INOX BLACK / KOY 105 SPORT INOX  
KOY 150 SPORT INOX BLACK / KOY 150 SPORT INOX  
KOY 200 SPORT INOX BLACK / KOY 200 SPORT INOX

Proposing our sleek and stylish Sport Design Truck Handrails, crafted from premium Stainless Steel or Stainless Steel painted in sophisticated Black Matt\*, crafted for both durability and style.

- Choose from four different sizes (80cm, 105cm, 150cm, 200cm) to perfectly fit your vehicle.

- Each handrail comes with a strained screw M10 for easy installation.
- Enjoy added reinforcement with two aluminum edges, featuring rubber finishing for a secure grip.
- Plastic taps for screws ensure a seamless and professional finish.

**Upgrade your truck's appearance and functionality with our premium handrails.**

\* (BLACK MATT: painted in 180°C for 30 minutes, an advanced process certified with the international standards 9001:2000 (Quality Management Systems) & 14001:2004 (Environmental Management Systems) and «SEASIDE CLASS» quality seal of the company QUALICOAT)).

## RB Kit

### CODE: RB-KIT

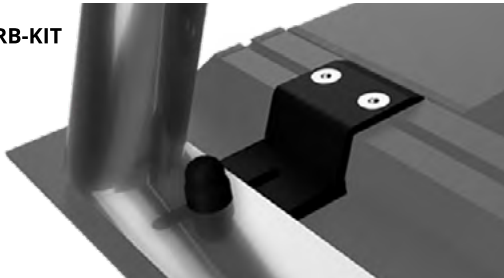

Presenting our revolutionary RB-KIT:

- Elevate your Tessera SE series experience with our specially crafted roll bar kit.

- Seamlessly integrates into the built-in "T-Slots" without any drilling required.
- Unlock endless possibilities for accessorizing without compromising structural integrity.

- Engineered for light accessory use, supporting a maximum load of 70kg.

**Elevate your setup effortlessly with our RB-KIT.**

## KOY Kit

### CODE: KOY-KIT



Elevate Your Tessera Experience with KOY-KIT Handrails:

- Crafted to Fit Perfectly: Specially designed to seamlessly integrate into the built-in "T-Slots" of Tessera SE, ensuring a flawless installation.

- No Drilling Required: Say goodbye to messy installations! With KOY-KIT, simply slide into place for effortless setup, preserving the integrity of your Tessera4x4 system.

- Enhanced Convenience: Enjoy added functionality without compromising on aesthetics. Perfect for light accessory use, with a maximum load capacity of 70kg.

## Cross Racks



### CODE:

BAR 920 INOX BLACK / BAR 920 INOX

Introducing our sleek Stainless Steel or Stainless Steel stylishly painted Black Matt\* cross racks!

- Designed with precision and durability, these racks feature Thule fitting brackets for seamless installation of cover & roller lids.

**Elevate your journey with this premium pair, perfect for those who demand both functionality and style.**

\* (BLACK MATT: painted in 180°C for 30 minutes, an advanced process certified with the international standards 9001:2000 (Quality Management Systems) & 14001:2004 (Environmental Management Systems) and «SEASIDE CLASS» quality seal of the company QUALICOAT)).



# The Company

Elevating the standards of innovation and precision, Tessera4x4 Accessories has cemented its position as a trailblazer in the realm of 4x4 vehicle enhancements for over four decades.



With an unwavering commitment to excellence, we have emerged as one of Europe's premier manufacturers for top-of-the-line accessories tailored specifically for pickup trucks and SUVs.

While our stronghold in the Greek market is undeniable, Tessera4x4 Accessories proudly ships products to over 40 countries across five continents, showcasing our global reach and influence. In addition to our renowned roll top covers, our lineup includes Roll Bars, Side handrails, cross racks, and other accessories.

Our design team is dedicated to staying ahead, constantly seeking out the latest trends and technologies to meet the evolving needs of our discerning clientele.

Experience the pinnacle of innovation and excellence with Tessera4x4 Accessories – where passion meets precision to redefine the future of pickup truck accessories.

DISCLAIMER: Vehicles and accessories as shown in this brochure are only for illustration purposes and may vary from the accessories as available in your market. The color of any accessory as shown in this brochure is subject to the limitations of the computer-generated imagery technique and may vary from the color of the actual items. No party can derive any rights from this brochure with respect to any availability or presentation of the vehicles and accessories shown. No part of this brochure may be copied, reproduced, distributed, made available, modified, edited, changed, used or served for any purposes without the prior written approval of Tessera4x4 accessories.

## 8 Patents



## Certified Quality





**TESSERA<sup>4</sup>**  
OFF ROAD ACCESSORIES

**4x4**

*Think Quality!*

Tessera4x4



## **Tessera4x4 accessories**

19.5 km EO Athinon Korinthou  
Elefsina, Greece, Zip Code: 19200  
GPS address: 38.050320, 23.564402

Tel: (+30) 210 5542813 - 5541161 - 5541154

Mobile: (+30) 6947901533

Fax: (+30) 210 5541 443

email: [info@gianso.gr](mailto:info@gianso.gr)

[www.tessera4x4.com](http://www.tessera4x4.com)

ON SOCIAL MEDIA

FOLLOW US

